



CHRYSLER GRAND VOYAGER V
LANCIA GRAND VOYAGER (RT)

02/2008 -
11/2011 -

Cat. No. CH/025

E20 E20*55R01/07*005498*00

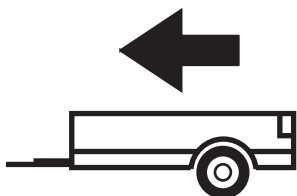



2025kg



140kg

D = 11,53kN

$$D \text{ (kN)} = \frac{\text{MAX kg} \times \text{MAX kg}}{\text{MAX kg} + \text{MAX kg}} \times 0,00981$$





IMIOLA HAK-POL

96-111 KOWIESY, CHOJNATA 23A, POLAND

Tel. + 48 46 831 73 31, fax +48 831 74 29

e-mail: office@imiola.pl, www.imiola.pl

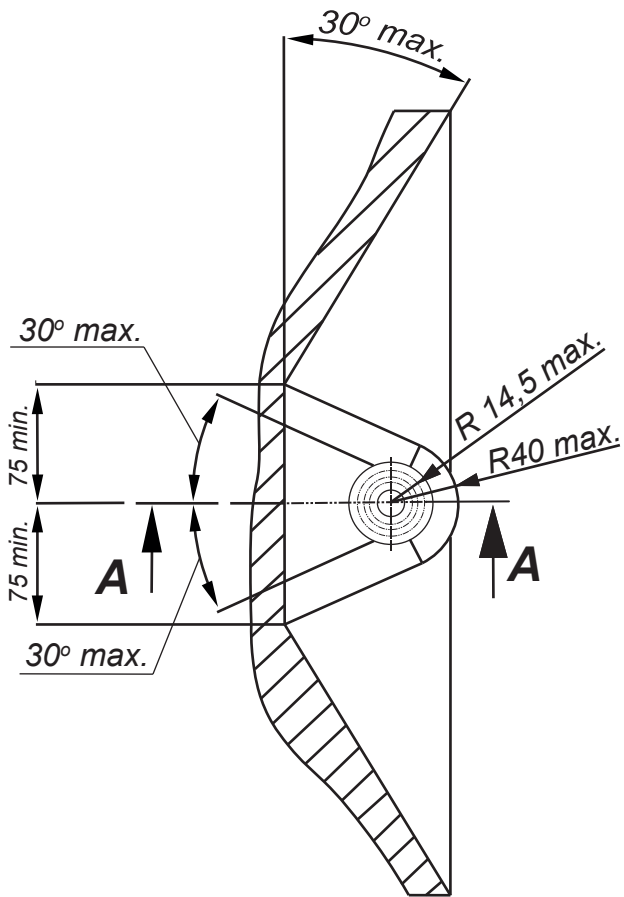

PRZEKRÓJ A-A

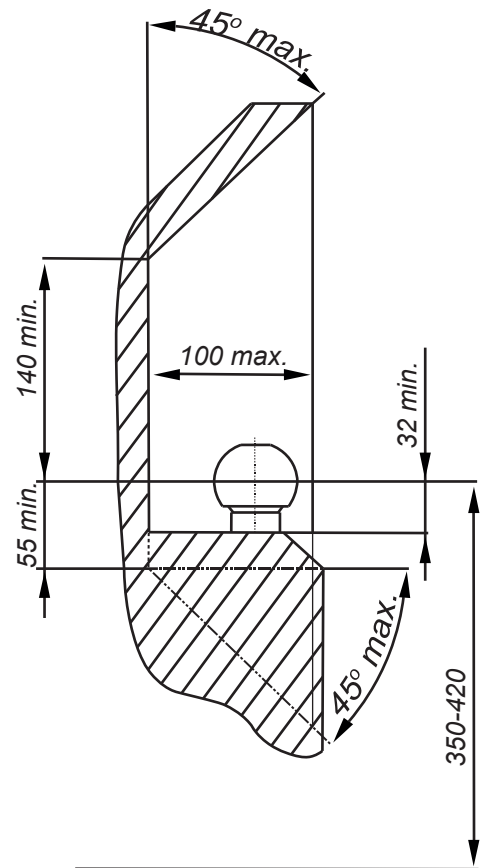

PL Należy zagwarantować przestrzeń swobodną według załącznika VII, rysunek 25a/b Regulaminu EKG ONZ 55.01 przy dopuszczalnym ciężarze całkowitym pojazdu.

F L'espace libre doit être garanti conformément à l'annexe VII, illustration de la réglementation 55.01 CE pour un poids total en charge autorisé du véhicule.









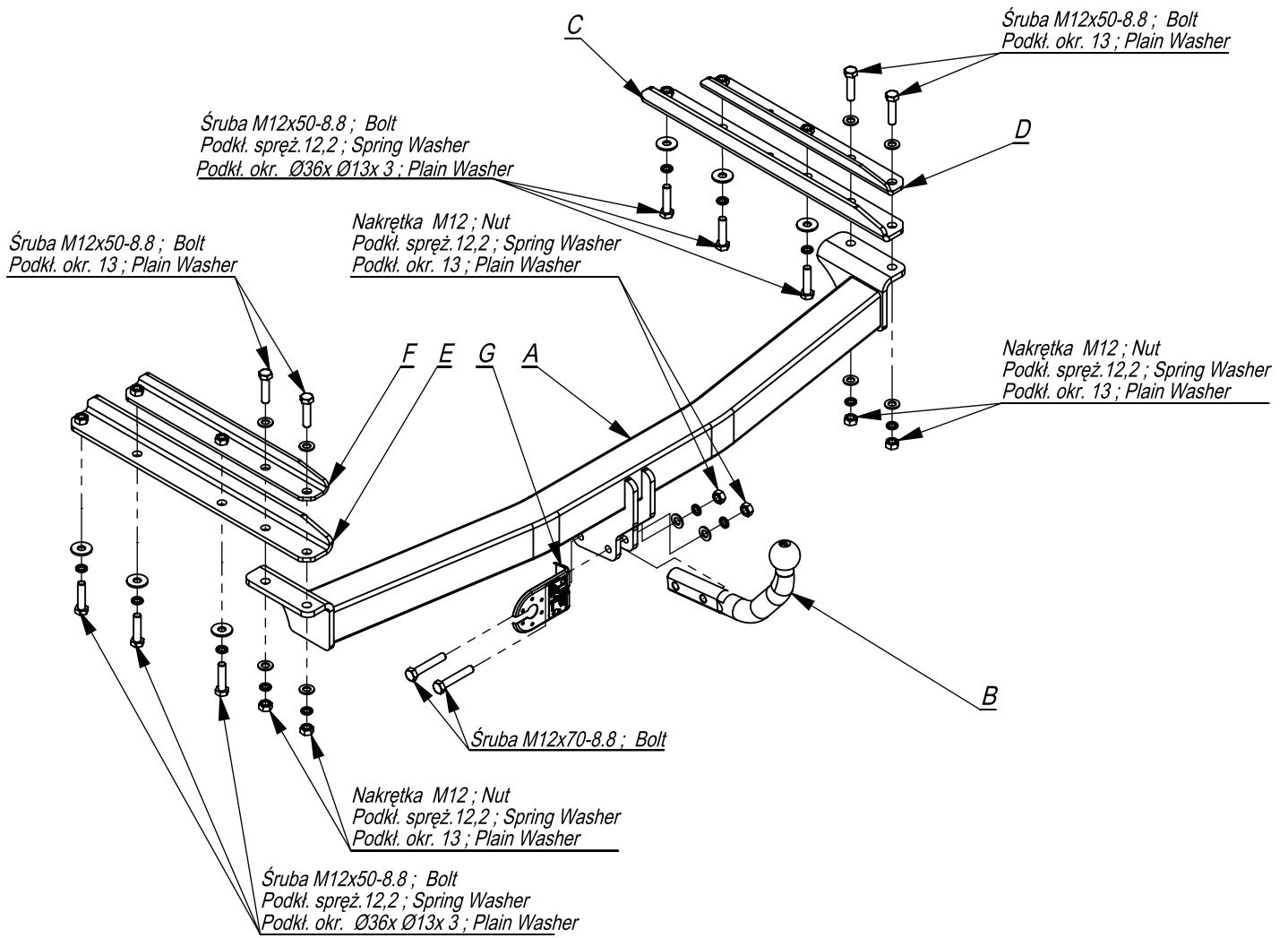

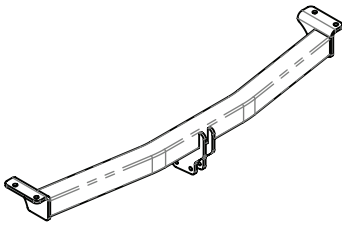
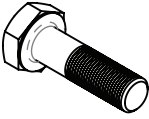
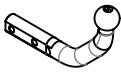
GB The clearance specified in appendix VII, diagram 25a/b of Regulation No. 55.01 UN EU must be guaranteed at laden weight of the vehicle.

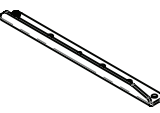
D Der Freiraum nach Anhang VII, Abbildung 25a/b der Vorschriften 55.01 EG ist zu gew 25a/bahrleisten bei zulässigem Gesamtgewicht des Fahrzeuges.

Moment skręcący dla śrub i nakrętek (8.8) Torque settings for nuts and bolts (8.8)	
M8	25Nm
M10	55Nm
M12	85Nm
M14	135Nm
M16	195Nm

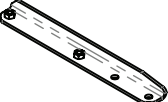

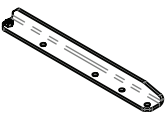

	A	x1		M12x70	2
				M12x50	10
	B	x1		M12	6
	C	x1		Ø36xØ13x3	6
	D	x1		13	10
	E	x1		12,2	12
	F	x1			
	G	x1			

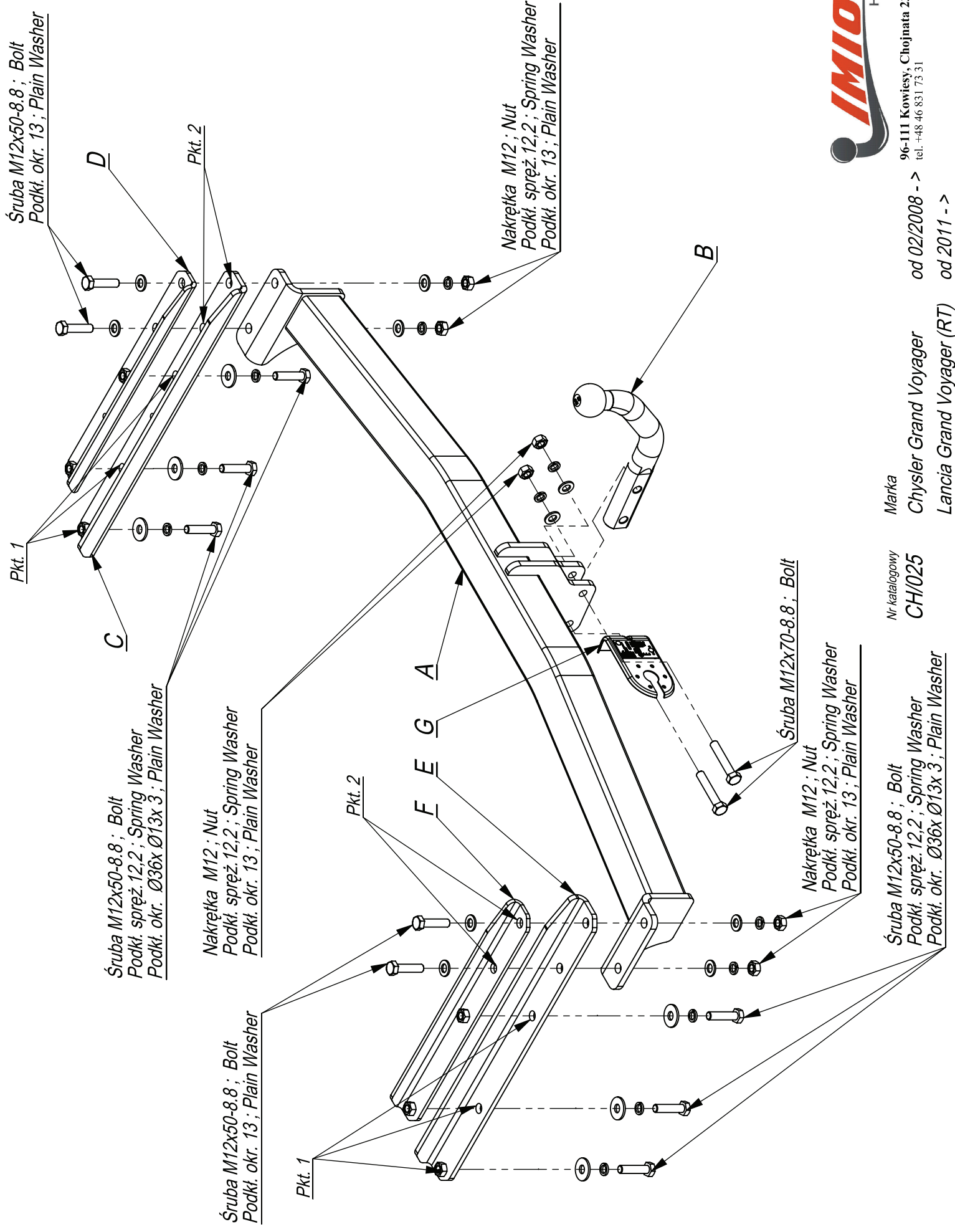

Śruba M12x50-8.8 ; Bolt
Podkł. okr. 13 ; Plain Washer

Pkt. 1

Śruba M12x50-8.8 ; Bolt
Podkł. spręż. 12,2 ; Spring Washer
Podkł. okr. Ø36x Ø13x 3 ; Plain Washer

C

Nakrętka M12 ; Nut
Podkł. spręż. 12,2 ; Spring Washer
Podkł. okr. 13 ; Plain Washer

Pkt. 2

Śruba M12x50-8.8 ; Bolt
Podkł. okr. 13 ; Plain Washer

Pkt. 1

Pkt. 2

F E G A

Nakrętka M12 ; Nut
Podkł. spręż. 12,2 ; Spring Washer
Podkł. okr. 13 ; Plain Washer

Śruba M12x70-8.8 ; Bolt
Nakrętka M12 ; Nut
Podkł. spręż. 12,2 ; Spring Washer
Podkł. okr. 13 ; Plain Washer

Śruba M12x50-8.8 ; Bolt
Podkł. spręż. 12,2 ; Spring Washer
Podkł. okr. Ø36x Ø13x 3 ; Plain Washer



96-111 Kowiesy, Chojnata 23 A
tel. +48 46 831 73 31

Marka
Chrysler Grand Voyager
Lancia Grand Voyager (RT)

Nr katalogowy
CH/025

od 02/2008 ->
od 2011 ->

- Odkręcić tylne lampy, zderzak i wypełnienie w zderzaku (nie będzie już potrzebne).
- Elementy E i F przykręcić lekko do spodu samochodu śrubami M12x50 (pkt 1).
- Belkę haka A przyłożyć do elementów i przykręcić śrubami M12x50 (pkt 2).
- Dokręcić wszystkie śruby z momentem według tabeli.
- Przykręcić zderzak i lampy.
- Dokręcić kulę i blachę gniazda elektrycznego.
- Podłączyć instalację elektryczną.

- Unscrew the rear lamps, bumper and filling in the bumper (it will no longer be needed).
- Fasten parts E and F lightly to the bottom of the car with M12x50 screws (point 1).
- Apply the hook A to the elements and fasten with bolts M12x50 (point 2).
- Tighten all bolts according to the table.
- Screw the bumper and lamp.
- Tighten the ball and the electric socket plate.
- Connect the electrical installation.

- Dévissez les feux arrière, le pare-chocs et le remplissage du pare-chocs (il ne sera plus nécessaire).
- Fixez légèrement les pièces E et F au bas de la voiture avec des vis M12x50 (point 1).
- Appliquez le crochet A sur les éléments et fixez avec les vis M12x50 (point 2).
- Serrez tous les boulons conformément au tableau.
- Visser le pare-chocs et le pare-chocs.
- Serrez la bille et la plaque de prise électrique.
- Connectez l'installation électrique.

- Die Hinterbeleuchtung, die Stoßstange und die Stoßstangeschürze abschrauben (wird nicht wieder gebraucht).
- Die Tragteile E und F von unten des Wagens mit den Schrauben M12x50 (Punkt 1) locker anschrauben.
- Den Querbalken A an die Tragteile anlegen und mit den Schrauben M12x50 (Punkt 2) anschrauben.
- Alle Schrauben mit dem in der Tabelle angegebenen Drehmoment festziehen.
- Die Stoßstange und die Beleuchtung einbauen.
- Die Kugel und die Steckdosenhalterung anschrauben.
- Die Elektroinstallation anschließen.

- Desenrosque las luces traseras, el paragolpes y el parachoques (ya no será necesario).
- Fije ligeramente las partes E y F a la parte inferior del automóvil con tornillos M12x50 (punto 1).
- Aplique el gancho A a los elementos y apriéte los con pernos M12x50 (punto 2).
- Apriete todos los pernos de acuerdo con la tabla.
- Atornille el parachoques y el faldón.
- Apriete la bola y la placa del enchufe eléctrico.
- Conecte la instalación eléctrica.

