



OPEL ASTRA

htb. (F,A)

09/1991 - 2001

Cat. No.: O/003

e20

e20*94/20*0133*00

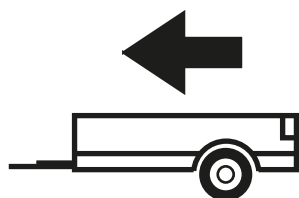

1 500kg

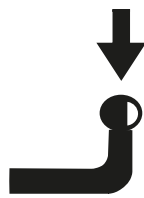

75kg

D = 8,10kN

D (kN) =



MAX kg

x

MAX kg

x 0,00981



MAX kg

+

MAX kg



IMIOLA HAK-POL

96-111 KOWIESY, CHOJNATA 23A, POLAND

tel. +48 46 831 73 31, fax +48 831 74 29

e-mail: office@imiola.pl, www.imiola.pl

Rys. 25a

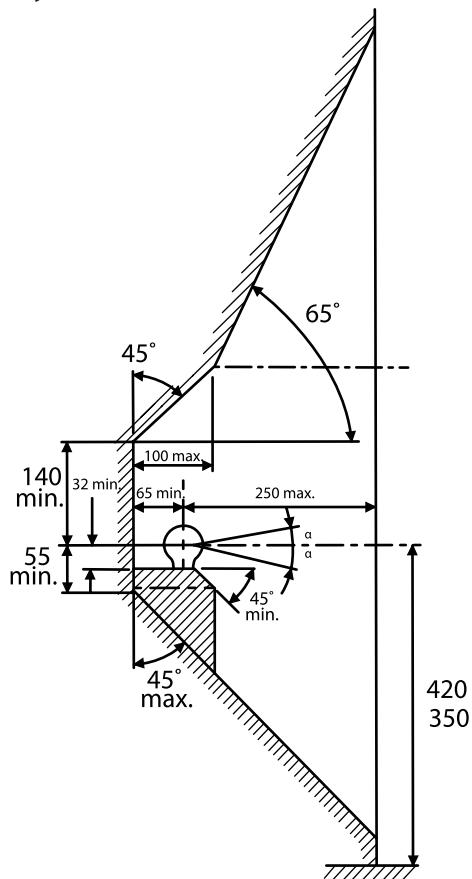

Rys. 25b

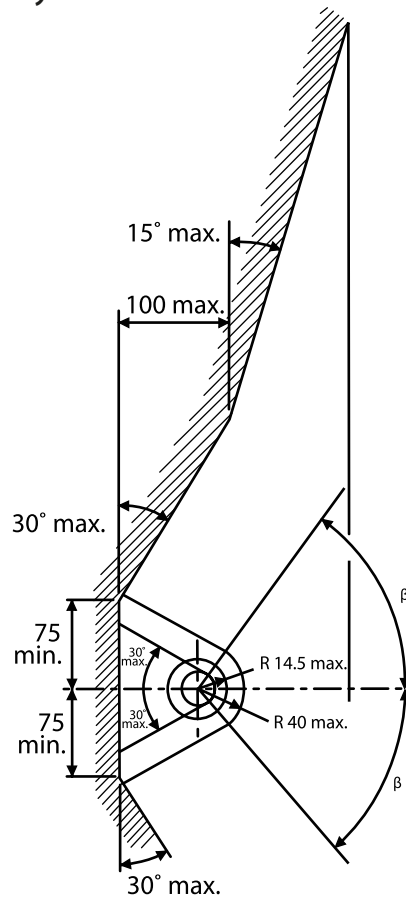

PL Należy zagwarantować przestrzeń swobodną według załącznika VII, rysunek 25a/b Regulaminu EKG ONZ 55.01 przy dopuszczalnym ciężarze całkowitym pojazdu.

GB The clearance specified in appendix VII, diagram 25a/b of Regulation No. 55.01 UN EU must be guaranteed at laden weight of the vehicle.







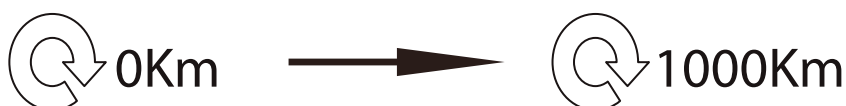

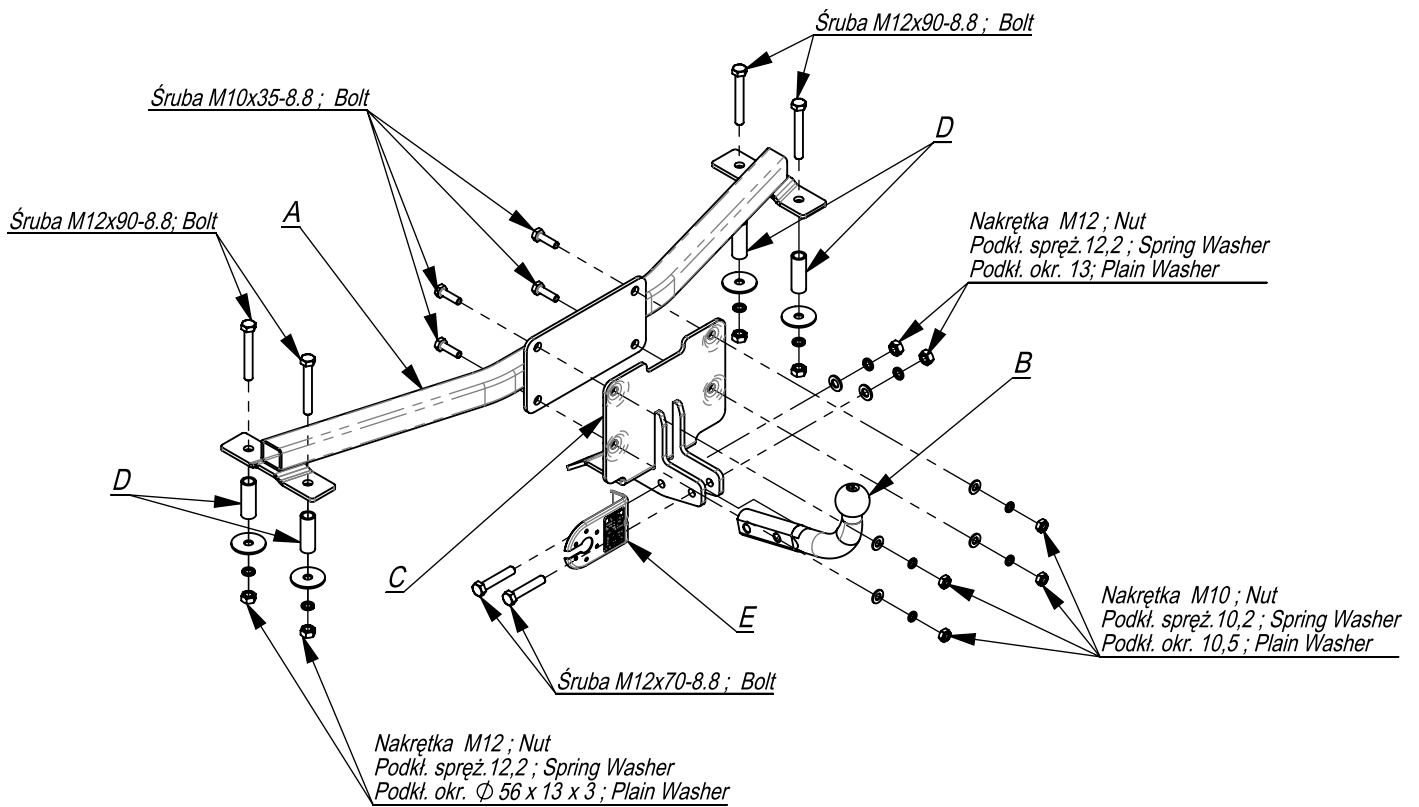
FR L'espace libre doit être garanti conformément à l'annexe VII, illustration de la réglementation 55.01 CE pour un poids total en charge autorisé du véhicule.

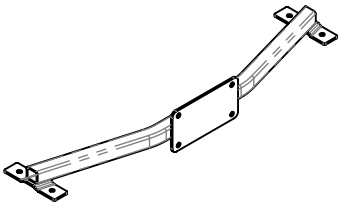
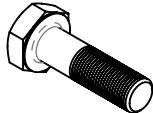
DE Der Freiraum nach Anhang VII, Abbildung 25a/b der Vorschriften 55.01 EG ist zu gew 25a/b abzuwehren bei zulässigem Gesamtgewicht des Fahrzeuges.

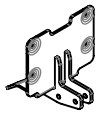
Moment skręcący dla śrub i nakrętek (8.8) Torgue settings for nuts and bolts (8.8)	
M8	25Nm
M10	55Nm
M12	85Nm
M14	135Nm
M16	195Nm





	A	x1		M12x90	4
				M12x70	2
				M10x35	6
	B	x1		M12	6
				M10	6
	C	x1		Φ 56x Φ 13x3	4
				Φ 30x Φ 10,5x3	2
	D	x4		13	2
				10,5	6
	E	x1		12,2	6
				10,2	6

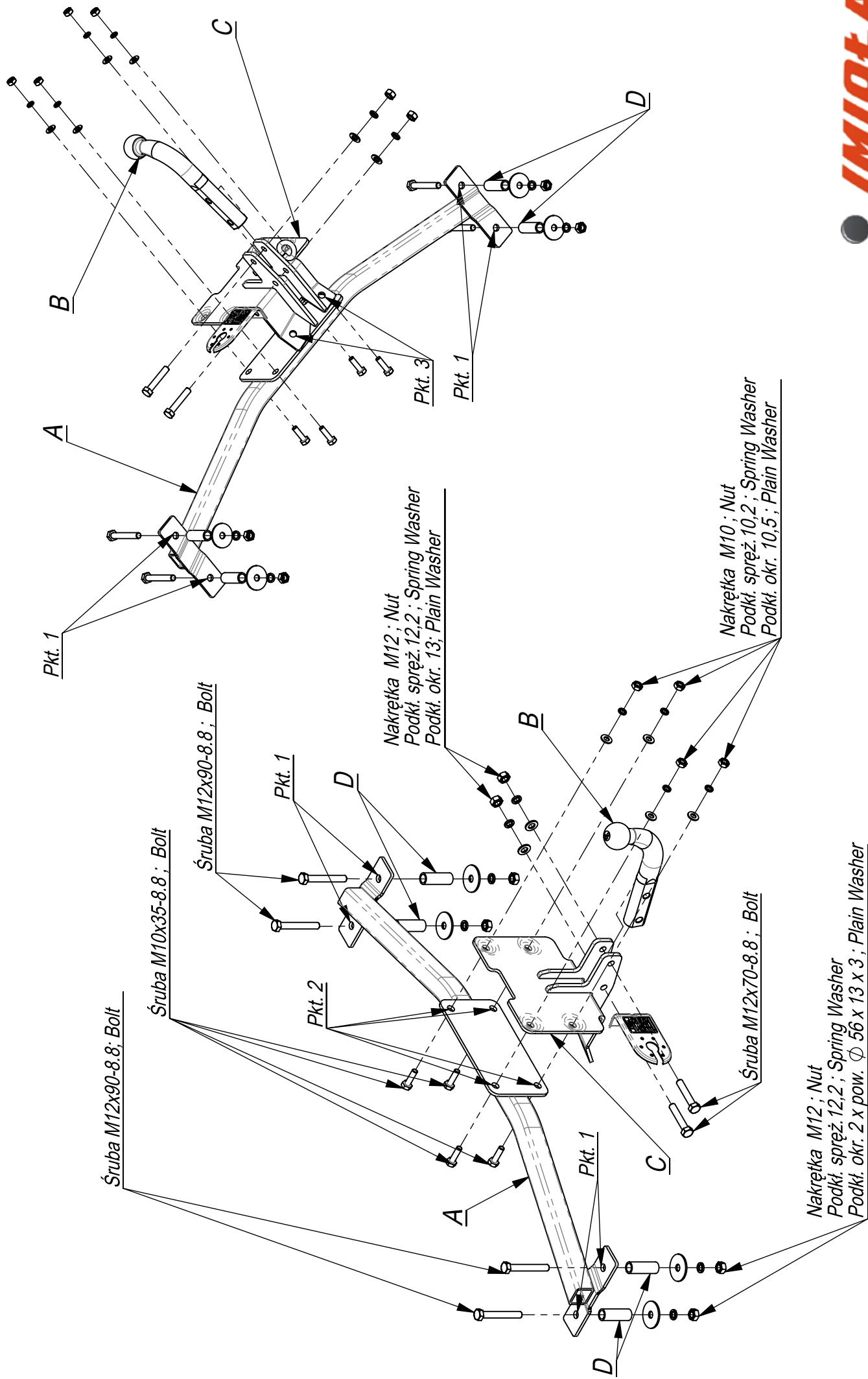

96-111 Kowiesy, Chojnata 23 A
 tel. +48 46 831 73 31

Nr katalogowy *O/003* Marka *Opeal Astra htb. (F, A)* od 09/91-01

