



2008 -

RENAULT KOLEOS

Cat. No. **R/A41**

(E20) 55R01/07*005625*00

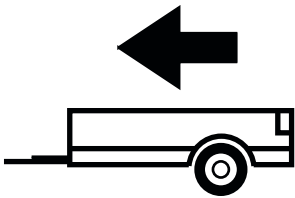

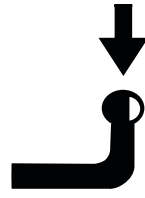

2000kg



100kg

D=10,50kN

$$D \text{ (kN)} = \frac{\text{MAX kg} \times \text{MAX kg}}{\text{MAX kg} + \text{MAX kg}} \times 0,00981$$

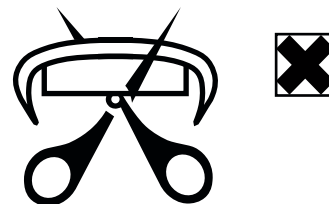
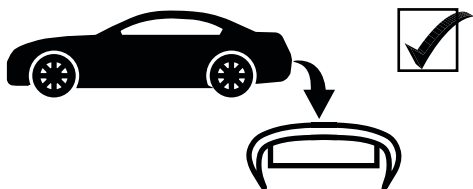



IMIOLA HAK-POL

96-111 KOWIESY, CHOJNATA 23A, POLAND

Tel. + 48 46 831 73 31, fax +48 831 74 29

e-mail: office@imiola.pl, www.imiola.pl

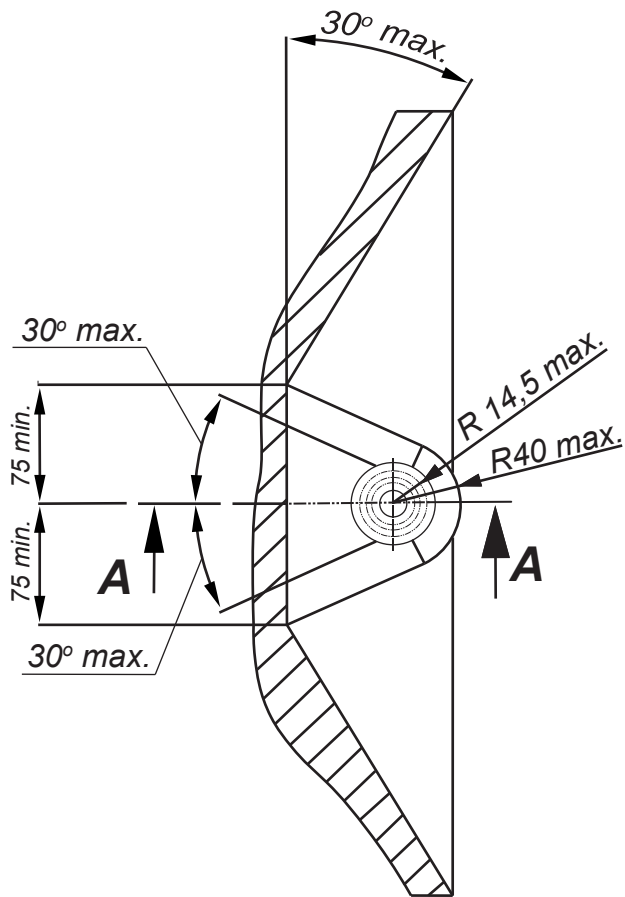

PRZEKRÓJ A-A

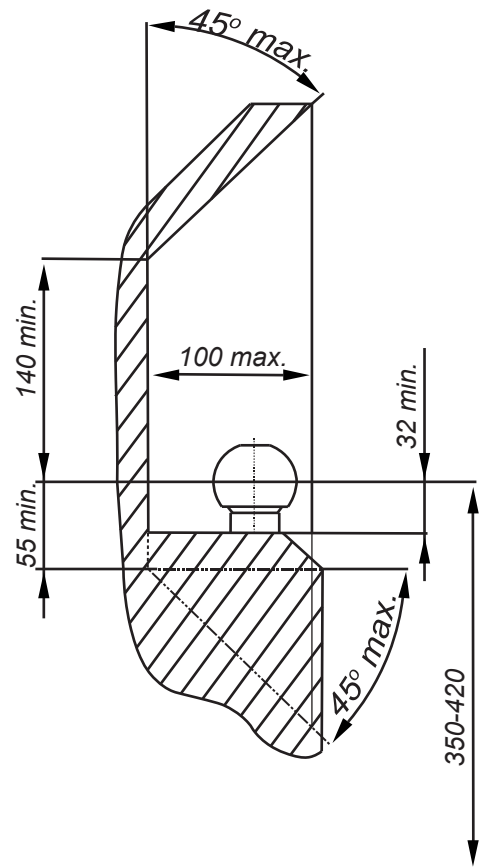

PL Należy zagwarantować przestrzeń swobodną według załącznika VII, rysunek 25a/b Regulaminu EKG ONZ 55.01 przy dopuszczalnym ciężarze całkowitym pojazdu.

F L'espace libre doit être garanti conformément à l'annexe VII, illustration de la réglementation 55.01 CE pour un poids total en charge autorisé du véhicule.

GB The clearance specified in appendix VII, diagram 25a/b of Regulation No. 55.01 UN EU must be guaranteed at laden weight of the vehicle.

D Der Freiraum nach Anhang VII, Abbildung 25a/b der Vorschriften 55.01 EG ist zu gewährleisten bei zulässigem Gesamtgewicht des Fahrzeuges.

Moment skracający dla śrub i nakrętek (8.8) Torque settings for nuts and bolts (8.8)	
M8	25Nm
M10	55Nm
M12	85Nm
M14	135Nm
M16	195Nm

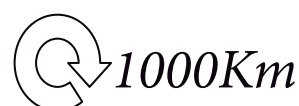

Śruba M10x35-8.8 ; Bolt
 Podkł. spręż. 10,2 ; Spring Washer
 Podkł. okr. 10,5 ; Plain Washer

Nakrętka M12 ; Nut
 Podkł. spręż. 12,2 ; Spring Washer
 Podkł. okr. 13 ; Plain Washer

Nakrętka M12 ; Nut
 Podkł. spręż. 12,2 ; Spring Washer
 Podkł. okr. 13 ; Plain Washer

Śruba M12x22-8.8 ; Bolt

Śruba M12x40-8.8 ; Bolt

Śruba M12x40-8.8 ; Bolt
 Podkł. spręż. 12,2 ; Spring Washer
 Podkł. okr. 13 ; Plain Washer

Śruba M10x1,25x30-8.8 ; Bolt
 Podkł. spręż. 10,2 ; Spring Washer
 Podkł. okr. 10,5 ; Plain Washer

Śruba M10x35-8.8 ; Bolt
 Podkł. spręż. 10,2 ; Spring Washer
 Podkł. okr. 10,5 ; Plain Washer

Śruba M10x35-8.8 ; Bolt
 Podkł. spręż. 10,2 ; Spring Washer
 Podkł. okr. 10,5 ; Plain Washer

Śruba M12x40-8.8 ; Bolt









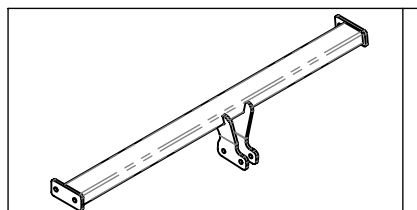
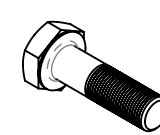

Śruba M12x22-8.8 ; Bolt

Śruba M12x22-8.8 ; Bolt
 Podkł. spręż. 12,2 ; Spring Washer

Śruba M12x22-8.8 ; Bolt
 Podkł. spręż. 12,2 ; Spring Washer

Śruba M12x40-8.8 ; Bolt
 Podkł. spręż. 12,2 ; Spring Washer
 Podkł. okr. 13 ; Plain Washer

Śruba M10x35-8.8 ; Bolt
 Podkł. spręż. 10,2 ; Spring Washer
 Podkł. okr. 10,5 ; Plain Washer

	A	x1		M12x40	4
	B	x1		M12	2
	C	x1		13	4
	D	x1		10,5	10
	E	x1		12,2	6
	F	x1		10,2	10
	G	x1			
	H	x1			
	I	x2			
	J	x1			

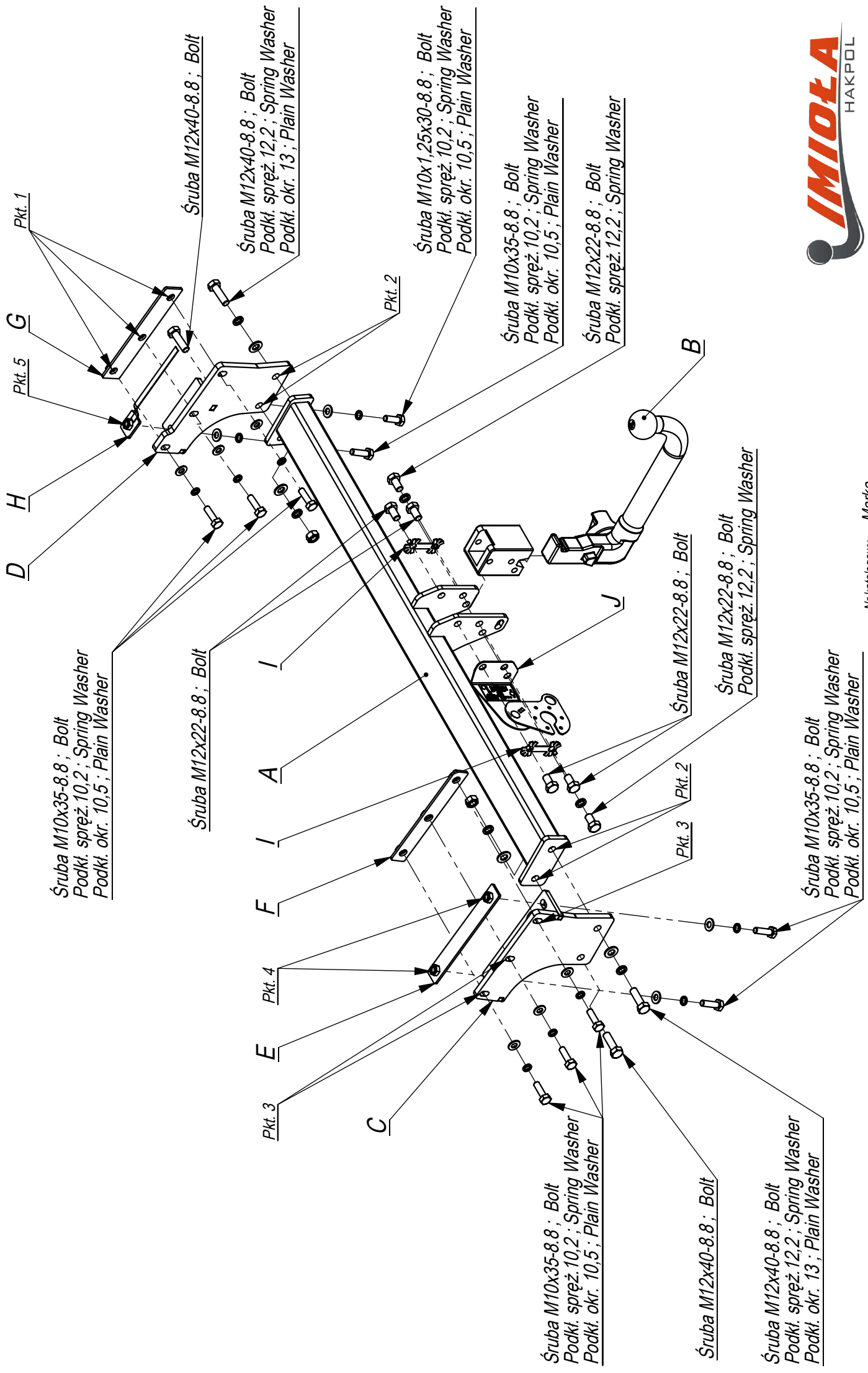

96-111 Kowiesy, Chojnata 23 A
tel. +48 46 831 73 31

Nr katalogowy Marka
R/A41 Renault Koleos od 2008 ->

Śruba M10x35-8.8; Bolt
Podkl. spręż. 10,2; Spring Washer
Podkl. okr. 10,5; Plain Washer

Śruba M12x40-8.8; Bolt

Śruba M12x22-8.8; Bolt
Podkl. spręż. 12,2; Spring Washer

Śruba M12x22-8.8; Bolt

Śruba M10x35-8.8; Bolt
Podkl. spręż. 10,2; Spring Washer
Podkl. okr. 10,5; Plain Washer

Śruba M10x35-8.8; Bolt
Podkl. spręż. 10,2; Spring Washer
Podkl. okr. 10,5; Plain Washer

Śruba M10x1,25x30-8.8; Bolt
Podkl. spręż. 10,2; Spring Washer
Podkl. okr. 10,5; Plain Washer

Śruba M12x40-8.8; Bolt
Podkl. spręż. 12,2; Spring Washer
Podkl. okr. 13; Plain Washer

Śruba M12x40-8.8; Bolt

Śruba M10x35-8.8; Bolt
Podkl. spręż. 10,2; Spring Washer
Podkl. okr. 10,5; Plain Washer

Śruba M12x22-8.8; Bolt

